

PJCL

Floor to Wall Pan Expansion Joint Covers

IMPORTANT

The following instructions are very important.

Read them carefully, and be sure you understand them completely before you begin any work.

Store this product in the horizontal position in a clean, dry location. This is a finished product. Store this product in a protected area. Do not stack anything on top of this product.

Review approved Balco shop drawings for types and locations prior to beginning work.

RECOMMENDED TOOLS

TAPE MEASURE / CHOP SAW / DRILL / DRILL BITS FOR CONCRETE AND METAL / SCREWDRIVERS AND SOCKET DRIVERS

STEP ONE

If fire barrier is provided in conjunction with the joint cover system, install the fire barrier at this time.

Install the fire barrier in accordance with the applicable fire barrier installation instructions and Balco shop drawings or details.

STEP TWO

If water barrier is to be installed in conjunction with the joint cover system, place the water barrier in its installed position in the joint at this time.

Reference Balco supplementary installation instruction "EPDM Water Barrier Installation Instructions" for information regarding EPDM installation, splicing, and transitions.

PJCL Floor to Wall Pan Expansion Joint Covers

STEP THREE

Select a socket base member and place it in its installed position. Using the base member as a template, mark the locations for the anchors on the concrete.

Remove the base member and drill the anchor holes at the marked locations. Remove all dirt and debris from the anchor holes and blockouts.

IMPORTANT

Observe normal safety precautions when drilling to avoid all utilities and rebar.

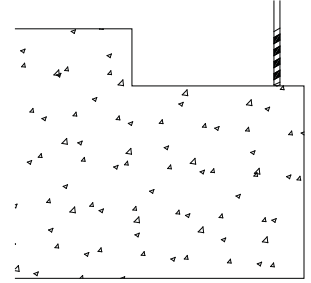
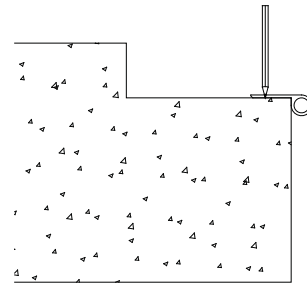

STEP FOUR

Place the socket base member into its installed position, and using the fasteners provided by the factory, attach it to the concrete.

Ensure it is plumb, level, and properly aligned.

Repeat **Steps Three and Four** until all socket base members are installed.

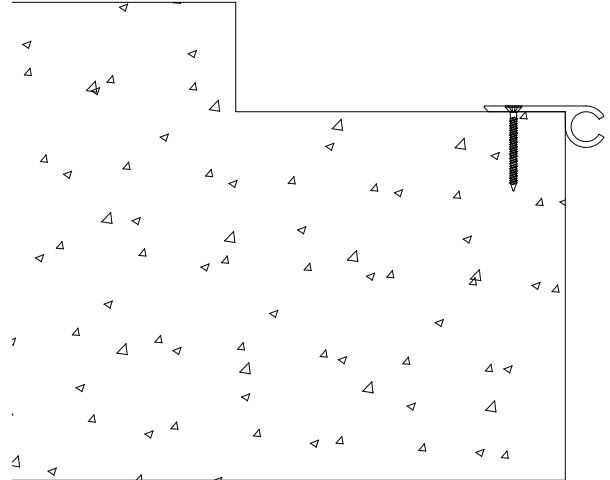

STEP FIVE

Select a ramp base member and place it in its installed position.

Using the base member as a template, mark the locations for the anchors on the concrete.

Remove the base member and drill the anchor holes at the marked locations. Remove all dirt and debris from the anchor holes and blockouts.

IMPORTANT

Observe normal safety precautions when drilling to avoid all utilities and rebar.

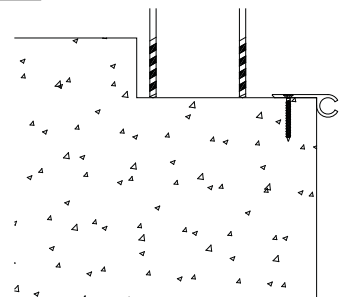
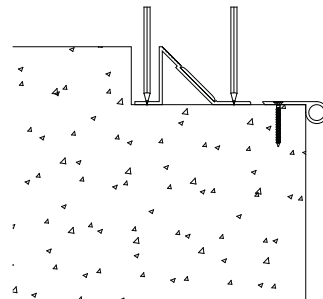

PJCL Floor to Wall Pan Expansion Joint Covers

STEP SIX

Place the ramp base member into its installed position, and using the fasteners provided by the factory, attach it to the concrete.

Ensure it is plumb, level, and properly aligned.

Repeat **Steps Five and Six** until all base members are installed.

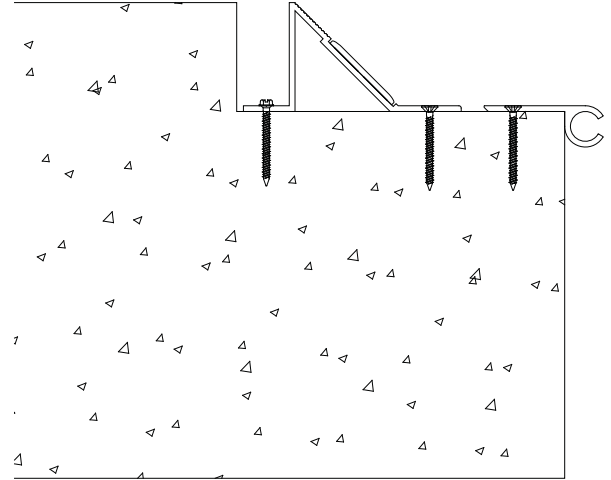

STEP SEVEN

If the system has been supplied without base member spacers, proceed to **Step Nine**.

If the system is provided with base member spacers, select a base member spacer and place it in its installed position.

Using the spacer as a template, mark the locations for the anchors on the concrete.

Remove the spacer and drill the anchor holes at the marked locations. Remove all dirt and debris from the anchor holes and blockouts.

IMPORTANT

Observe normal safety precautions when drilling to avoid all utilities and rebar.

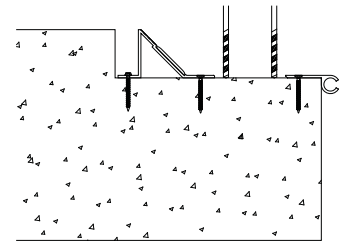
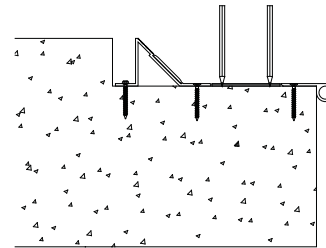

STEP EIGHT

Place the base member spacer into its installed position, and using the fasteners provided by the factory, attach it to the concrete.

Ensure it is plumb, level, and properly aligned.

Repeat **Steps Seven and Eight** until all base member spacers are installed.

NOTE

Base member spacers should fit loosely within the space between the ramp and socket base members. Do not install the base member spacers tight within the space between base members. If adjustment is required, use a power sander or a sharp utility knife to remove some material from the spacer.

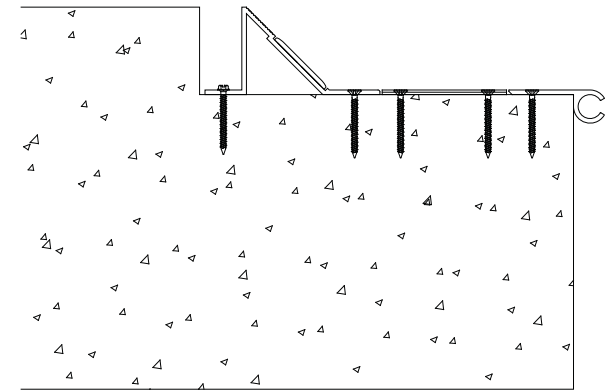

PJCL Floor to Wall Pan Expansion Joint Covers

STEP NINE

Select a wall base member and place it in its installed position.

Using the base member as a template, mark the locations for the anchors on the concrete.

Remove the base member and drill the anchor holes at the marked locations. Remove all dirt and debris from the anchor holes and blockouts.

IMPORTANT

Observe normal safety precautions when drilling to avoid all utilities and rebar.

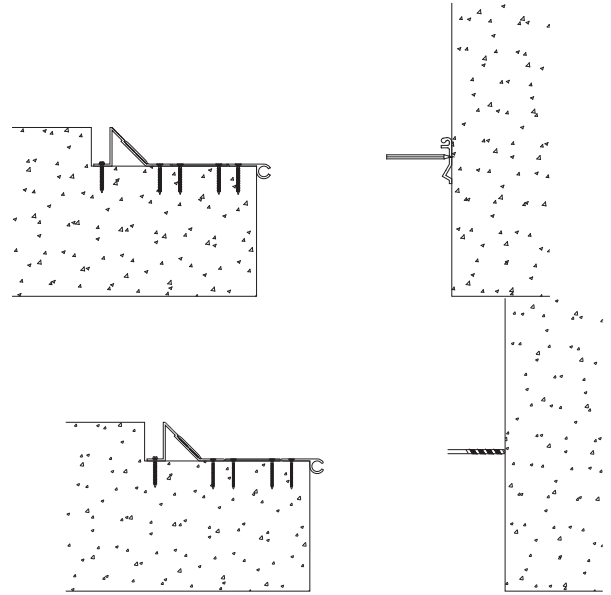

STEP TEN

Place the ramp base member into its installed position, and using the fasteners provided by the factory, attach it to the concrete.

Ensure it is plumb, level, and properly aligned.

Repeat **Steps Nine and Ten** until all wall base members are installed.

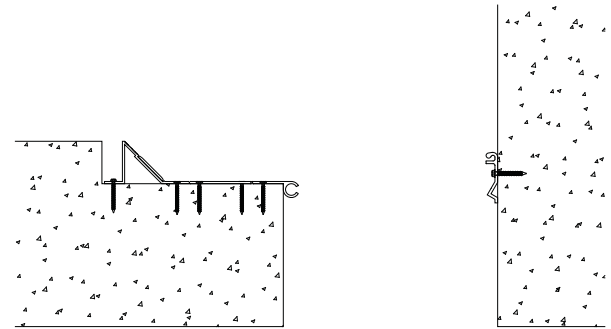

STEP ELEVEN

Select a section of cover pan.

If the section of cover pan has been cut to less than supplied stock length in the field, select two Tec screws.

Drill and countersink the anchor holes into the pans along both sides at 1" from the cut end of the pan.

Attach a screw to each side of the pan 1" from the cut end of the pan, tightly fastening the sub-members to the cover pan.

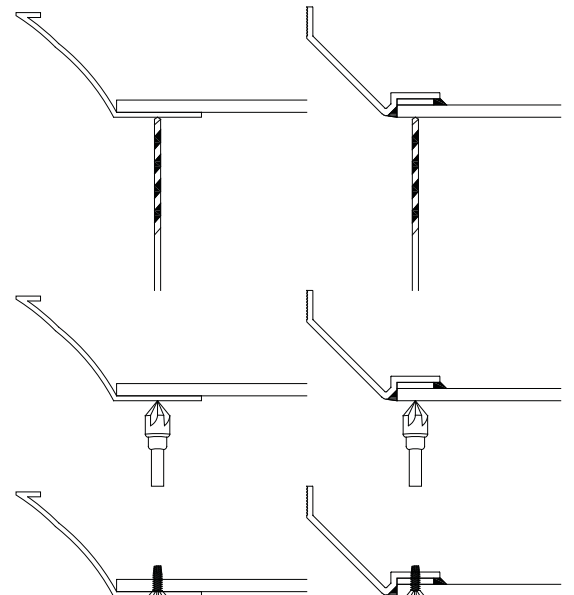

PJCL Floor to Wall Pan Expansion Joint Covers

STEP TWELVE

Select a cover plate and place the hook of the cover onto the rail of the base member.

Place the cover into its installed position spanning the joint.

Repeat until all covers are installed.

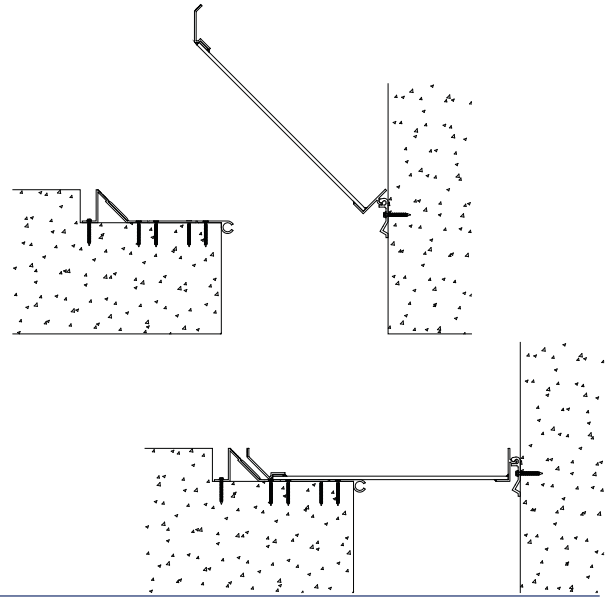

STEP THIRTEEN

Install the filler material (by others) into the cover pan. The filler material must be installed in accordance with the filler material's written instructions.

If concrete or grout are poured into the cover pan, ensure that all holes and gaps in the pan have been properly dammed.

Remove all excess grout or concrete from the exposed surfaces of the aluminum base before the grout or concrete sets up.

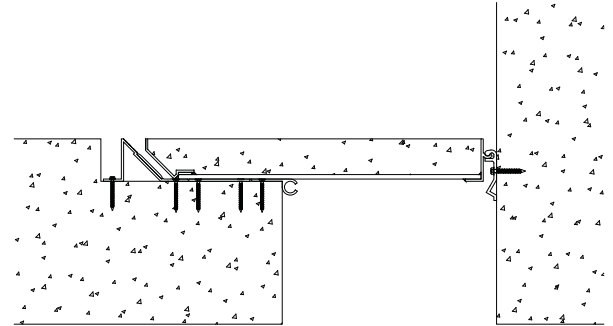

STEP FOURTEEN

Apply grout (by others) continuously between the base members and the blockout.

Install the grout in accordance with the grout manufacturer's written instructions.

Ensure that the grout is level with the surface of the surrounding concrete.

Remove all excess grout from the exposed surfaces of the aluminum base members before the grout sets up.

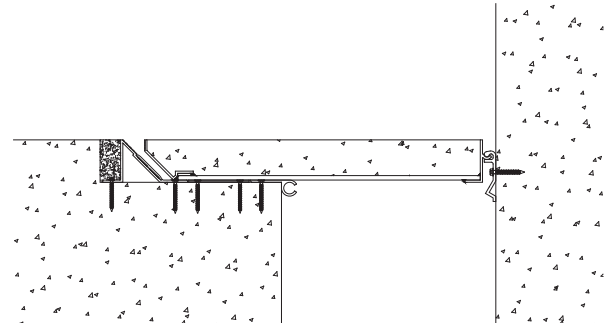

PJCL Floor to Wall Pan Expansion Joint Covers

STEP FIFTEEN

Apply backer rod and self-leveling elastomeric sealant to the gaps along either side of the cover pan. Install the backer rod and sealant in accordance with the manufacturer's written instructions.

Ensure that the sealant is flush with the finish floor.

Once all grouts and sealants are fully cured and the cover plates are installed, the installation can be opened to traffic.

CAUTION

Do not introduce air bubbles into sealant. Mix sealant slowly, in accordance with the manufacturer's written instructions. Air bubbles in the sealant may impact sealant performance.

BALCO RECOMMENDS

Sikaflex-2c SL sealant or equivalent. Approved alternate sealants include, but are not limited to:

- Sikaflex-1c SL
- Bostik 955 SL
- Tremco 445SL

Note: Only Sikaflex-2c SL sealant has been tested by Balco. Alternates have been approved based on sealant manufacturers' specifications. Contact factory for more information.

