

95GW-7

9500 SERIES DUAL ELASTOMERIC
 INTERIOR WALL & CEILING SYSTEM
 CLEAR ANODIZED FINISH ALUMINUM COVER
 MILL FINISH ALUMINUM BASE

COLOR: _____
 FILLER COLORS AVAILABLE:
 BLACK, WHITE, GRAY, TAN, OR BRONZE
 PLEASE SPECIFY

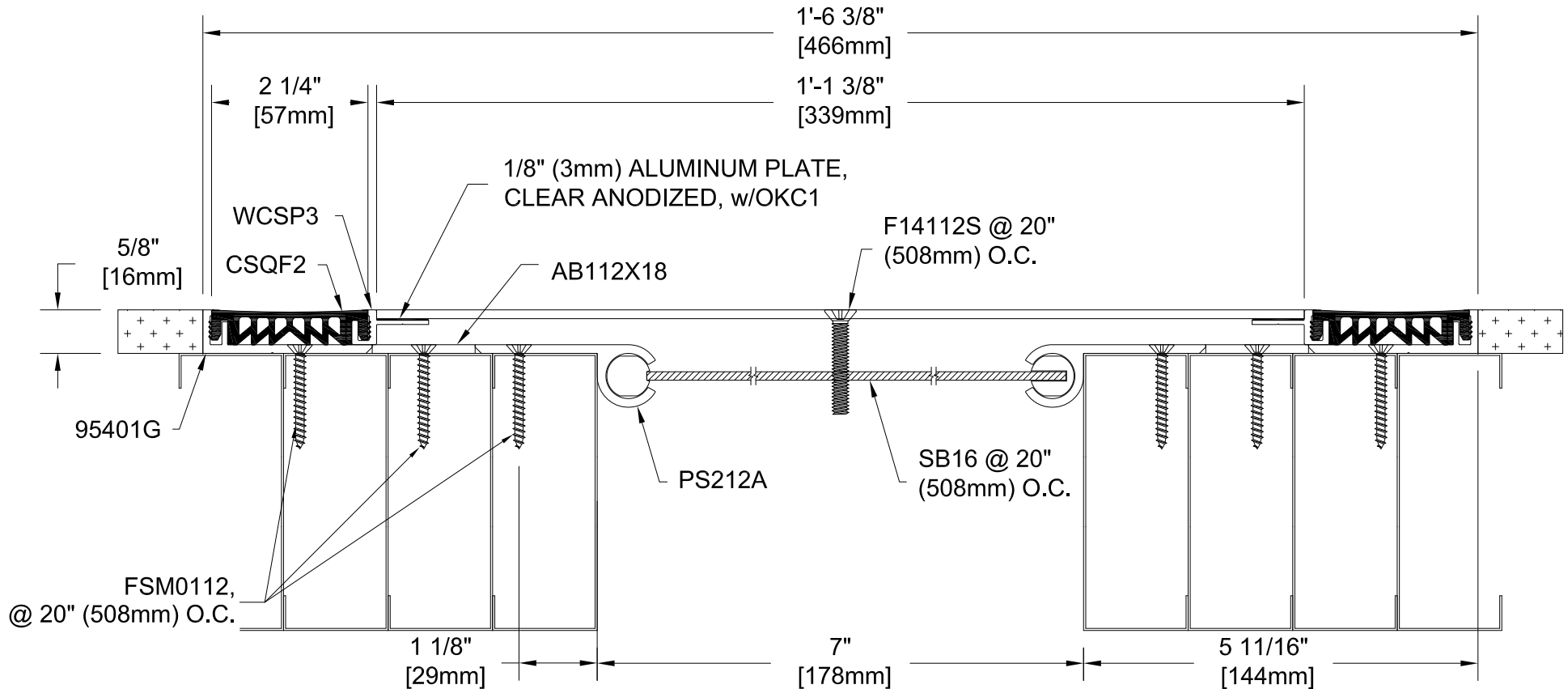

Project:	
Customer:	
SO#	
Date:	
Page ___ of ___	Scale: NTS

Length	Qty.	Color

Drawn By: RJT

The information contained herein is the proprietary property of **BALCO, INC.** No portion of it may be reproduced by any means or used in any form except for the purpose for which it was furnished. All rights of design and invention are hereby reserved.



2626 S. Sheridan PO Box 17249
 Wichita, Kansas 67217-0249 USA
 P: +1-316-945-9328 F: +1-316-945-0789