

75FCE-1

INTERIOR FLOOR TO FLOOR SYSTEM
 w/3/16"(5mm) RECESS FOR CARPET
 MILL FINISH ALUMINUM BASE
 APPROXIMATELY 25% MOVEMENT

COLOR: _____
 FILLER COLORS AVAILABLE:
 BLACK, GRAY, TAN, OR BRONZE
 PLEASE SPECIFY
 NOTE: ONLY BLACK IS UV RESISTANT
 (FOR EXTERIOR USE)

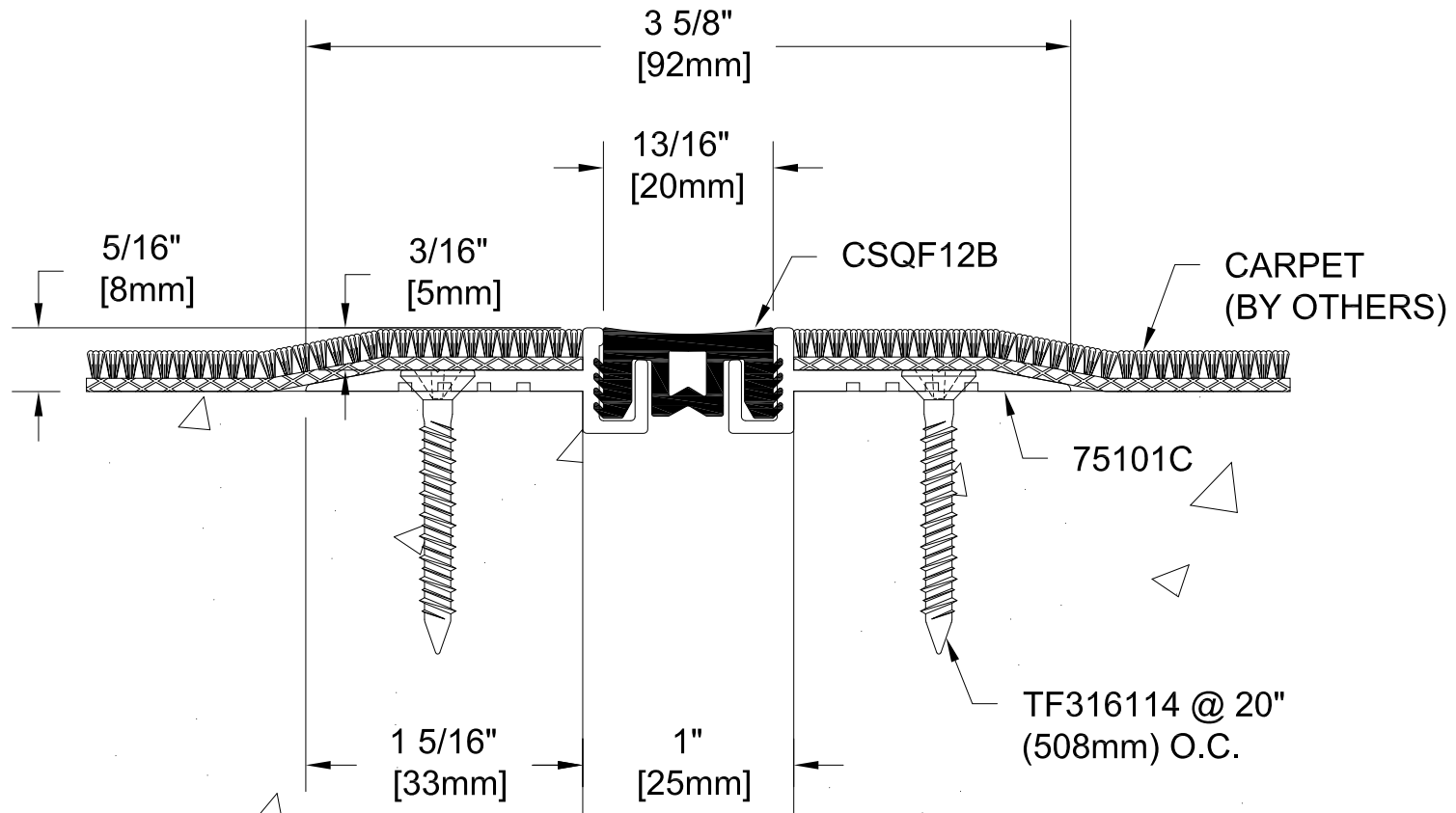

Project:	
Customer:	
SO#	
Date:	
Page ___ of ___	Scale: NTS

Length	Qty.	Color

Drawn By: RJT

The information contained herein is the proprietary property of **BALCO, INC.** No portion of it may be reproduced by any means or used in any form except for the purpose for which it was furnished. All rights of design and invention are hereby reserved.



BALCO INC
 2626 S. Sheridan PO Box 17249
 Wichita, Kansas 67217-0249 USA
 P: +1-316-945-9328 F: +1-316-945-0789

REV. - 6/08/12