

6FS-2-4

FLOOR TO FLOOR SYSTEM
 MILL FINISH ALUMINUM COVER
 MILL FINISH ALUMINUM BASE
 50% MOVEMENT

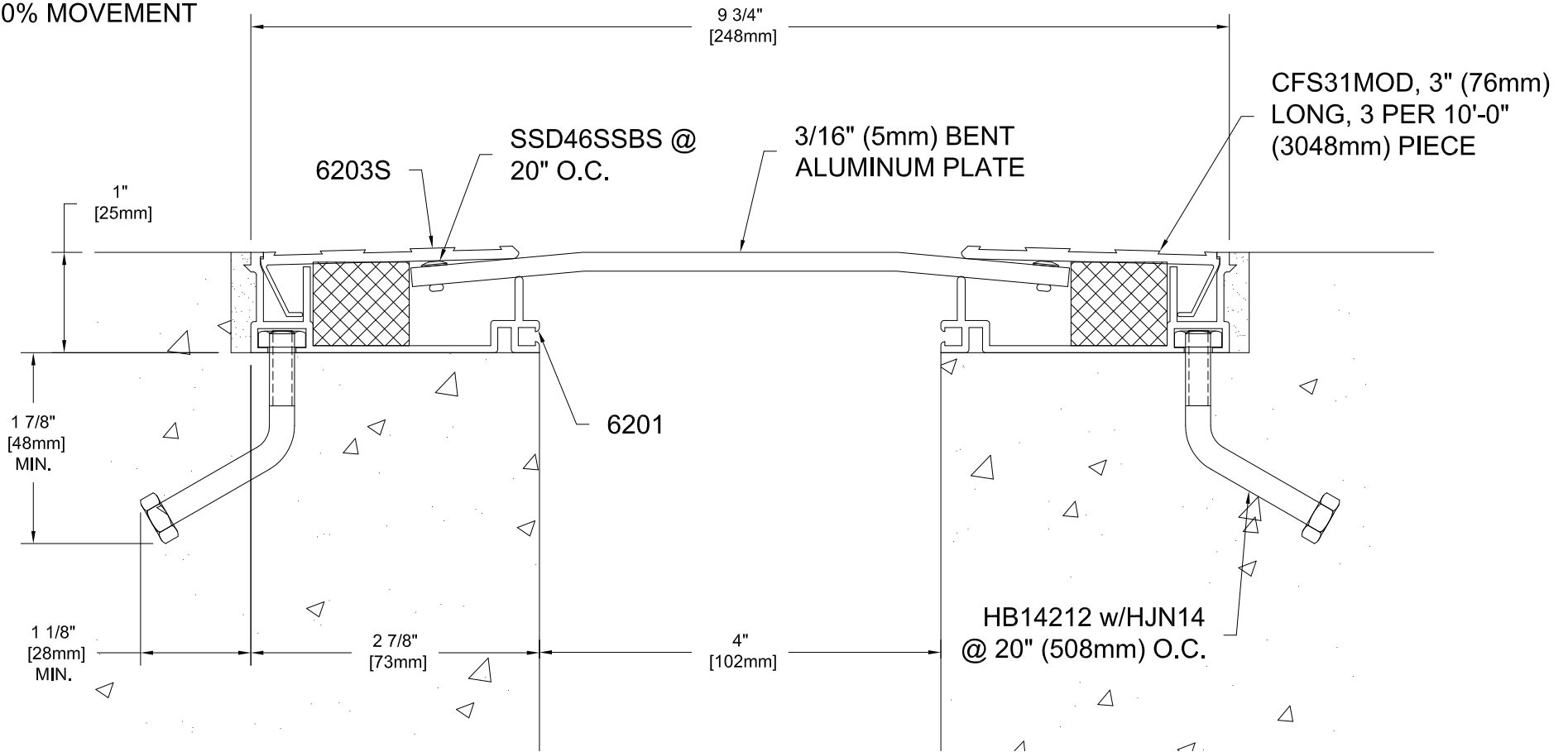

Project:	
Customer:	
SO#	
Date:	
Page ___ of ___	Scale: NTS

Length	Qty.	Color

Drawn By: TSH

The information contained herein is the proprietary property of **BALCO, INC.** No portion of it may be reproduced by any means or used in any form except for the purpose for which it was furnished. All rights of design and invention are hereby reserved.



2626 S. Sheridan PO Box 17249
 Wichita, Kansas 67217-0249 USA
 P: +1-316-945-9328 F: +1-316-945-0789