

NBR-9x3/8"
 NO-BUMP FLOOR TO FLOOR SYSTEM
 w/3/8" RECESS FOR TERRAZZO OR HARDBET TILE
 MILL FINISH ALUMINUM EXTRUSIONS
 MILL FINISH ALUMINUM PLATE
 100% MOVEMENT

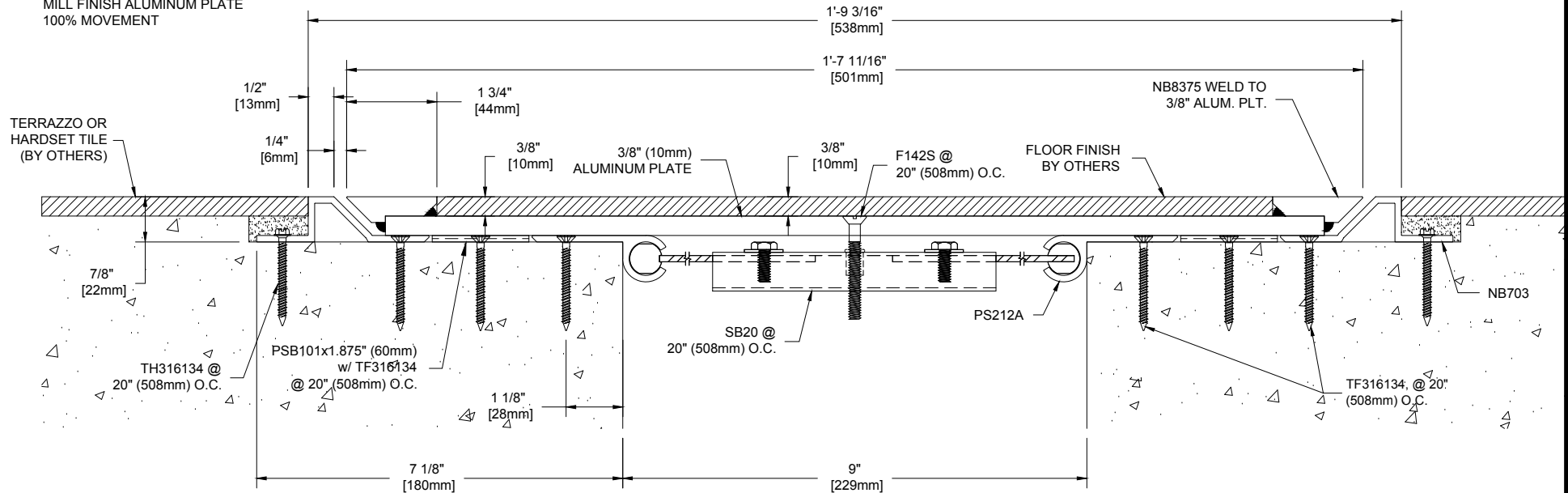

Project:	
Customer:	
SO#	
Date:	
Page ___ of ___	Scale: NTS

Length	Qty.	Color

Drawn By: HRS



A CSW Industrials Company

The information contained herein is the proprietary property of BALCO®. No portion of it may be reproduced by any means or used in any form except for the purpose for which it was furnished. All rights of design and invention are hereby reserved.

REV. - 12/01/17